

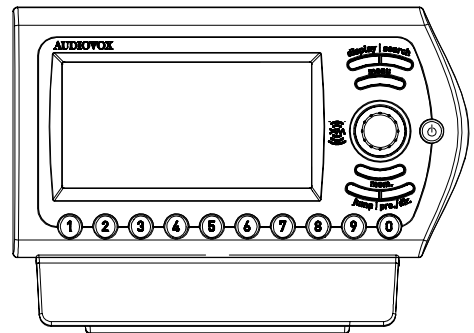

# Xpress<sup>®</sup> Satellite Radio Receiver

## XMC10 Car Cradle Installation Guide



Released: 9-15-05

128-7472

1 of 16

## **CONTENTS**

Congratulations .....	3
Cautions and Warnings .....	4
Contents XMC10 .....	5
Accessory Kit .....	5
Installation/Wiring Precautions .....	6
Setting Up and Installing Your Kit .....	7
Interconnect Diagram .....	6
Using Other Manufacturer's Mounts .....	9
Installing the Xpress XM® Into the Cradle .....	9
Connection Options .....	10
Mounting the Vehicle Antenna .....	12
Warranty .....	15

## ***Congratulations***

Thank you for purchasing the Audiovox Xpress XM<sup>®</sup> Satellite Car Kit. You are one step closer to experiencing the latest innovation in XM<sup>®</sup> Satellite Radio. XM<sup>®</sup> Satellite Radio will revolutionize your vehicle or in-home entertainment.

XM<sup>®</sup> features over 150 digital channels — 100% commercial-free music, over 30 channels of news, sports, talk and entertainment, over 20 dedicated channels of XM<sup>®</sup> Instant Traffic & Weather, and the deepest play-list in the industry with access to over 2 million titles!

XM<sup>®</sup> Satellite Radio service gives you the power to choose what you want to hear - wherever and whenever you want it. XM<sup>®</sup> is America's #1 Satellite Radio provider with over 4 million customers.

Your Audiovox Xpress XM<sup>®</sup> receiver must be used with an accessory kit, such as the Audiovox Home Kit, Boom Box or Vehicle Kit as required by your specific installation needs. These kits are available at retailers where Audiovox main units are sold.

Required subscription for service sold separately.

Installation costs and other fees and taxes may apply, including a one-time activation fee. All fees and programming subject to change. College sports games subject to availability. Subscriptions subject to Customer Agreement included with the XM Welcome Kit and available at [www.xmradio.com](http://www.xmradio.com). Only available in the 48 contiguous United States.

©2005 XM<sup>®</sup> Satellite Radio Inc. XM<sup>®</sup> is a trademark of XM<sup>®</sup> Satellite Radio. All rights reserved. All other trademarks are the property of their respective owners.

### ***Cautions and Warnings***

1. Do not install the XMC10 car cradle in a position that hinders your view through the windshield, or obstructs viewing of the dashboard indicators and displays.
2. Do not install the unit where it may obstruct the operation or deployment of safety devices, such as airbags, etc.
3. Do not allow operation of the unit to detract from safe driving practices; remember that you are responsible as the vehicle operator to adhere to all safe driving and traffic regulations.
4. This unit complies with the interference limits relative to a Class B digital device, applicable under Part 15 of the FCC Rules regarding installation in a residential environment. If the unit is not installed in accordance with these instructions, it could cause harmful interference to radio or television reception. If this condition persists after corrective action, consult your dealer or experienced installation facility.
5. By adhering to these warnings and safety considerations, serious accidents and/or personal injury can be avoided.

## Contents XMC10

Install Manual  
(P/N 1287472)

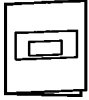

Antenna  
(P/N 118-1133)

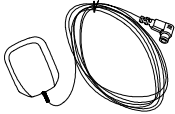

1 pc.

12 Volt-to-5 Volt  
DC Power Adapter  
(P/N 112-3456)

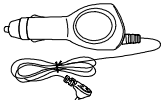

1 pc.

Swivel Bracket  
(P/N 136-4048)

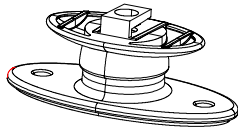

1 pc.

Cradle XMC10  
(P/N 136-4041)

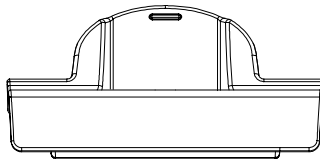

1 pc.

CLA Female Socket  
(P/N 154-1132)

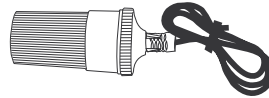

1 pc.

### ACCESSORY KIT

Alcohol Cleaning Pad,  
Surface Cleaning Pad,  
Instruction Sheet,  
Antenna Cable Exit Plug  
(P/N 170-0054)

### OPTIONAL

Audio Cable  
(P/N SAT-RCA)



1 pc.

FM Direct Adapter  
P/N XMFM-1

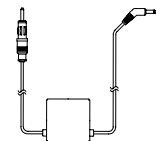

1 pc.

## ***Installation/Wiring Precautions***

1. To prevent a short-circuit, be sure to turn off the ignition and remove the negative (-) battery cable prior to installation. Connect power wires last.
2. Do not install the unit in the locations exposed to direct sunlight or, in areas subject to extreme temperatures.
3. Incorrect installation may cause damage to the system. Mount the unit firmly in place, using the supplied hardware.
4. Be careful not to damage the vehicle wiring.
5. Be sure to use the supplied screws and washers.
6. Be careful not to snag any wires when tightening screws.
7. Use only the 12 Volt-to-5 Volt DC Power Adapter supplied. Use of an alternative power adapter may damage the Xpress XM® unit and/or the XMC10 cradle.

**CAUTION:** You could drain the vehicle battery if the DC power adapter remains plugged in after the ignition is turned off. Unplug the adapter to prevent this possibility.

## ***Setting Up and Installing Your Kit***

**NOTE:** The XM signal can be received and processed virtually anywhere as long as there are no obvious satellite signal obstructions such as nearby buildings, high terrain, parking garages or tunnels.

### ***1. Cabling Interconnections***

You can begin to enjoy XM® Satellite Radio as soon as the Xpress XM® Receiver and Vehicle Kit installation are complete. Set up your Audiovox Xpress XM® System using the following installation instructions, or enlist the help of a professional installer:

### ***2. Installing the Cradle Mount Base Assembly***

- a. Interconnect all of the components as shown on the adjacent page to verify that the system operates normally.
- b. Locate a firm, reasonably flat surface within your car to permit optimum viewing and line-of-sight access by the supplied remote control unit.

## Interconnect Diagram

### NOTE:

1. IF THE XMC10 IS INSTALLED USING THE OPTIONAL XMFM-1 FM DIRECT ADAPTER, DO NOT CONNECT AN AUDIO CABLE TO THE LINE OUT CONNECTOR OF THE CRADLE.
2. THE FM TRANSMITTER OPTION MUST BE SET TO "FM ON" IN THE XPRESS XM USER MENU. (REFER TO THE OWNER'S MANUAL, PUBLICATION NO.128-7454.)

AUX AUDIO INPUT TO AUDIO OUTPUT OF EXTERNAL PLAYBACK DEVICE. THIS PERMITS AUDIO FROM AN EXTERNAL DEVICE SUCH AS A PORTABLE CD PLAYER OR MP3 PLAYER TO BE PLAYED THROUGH THE XPRESS XM WIRELESS FM TRANSMITTER.

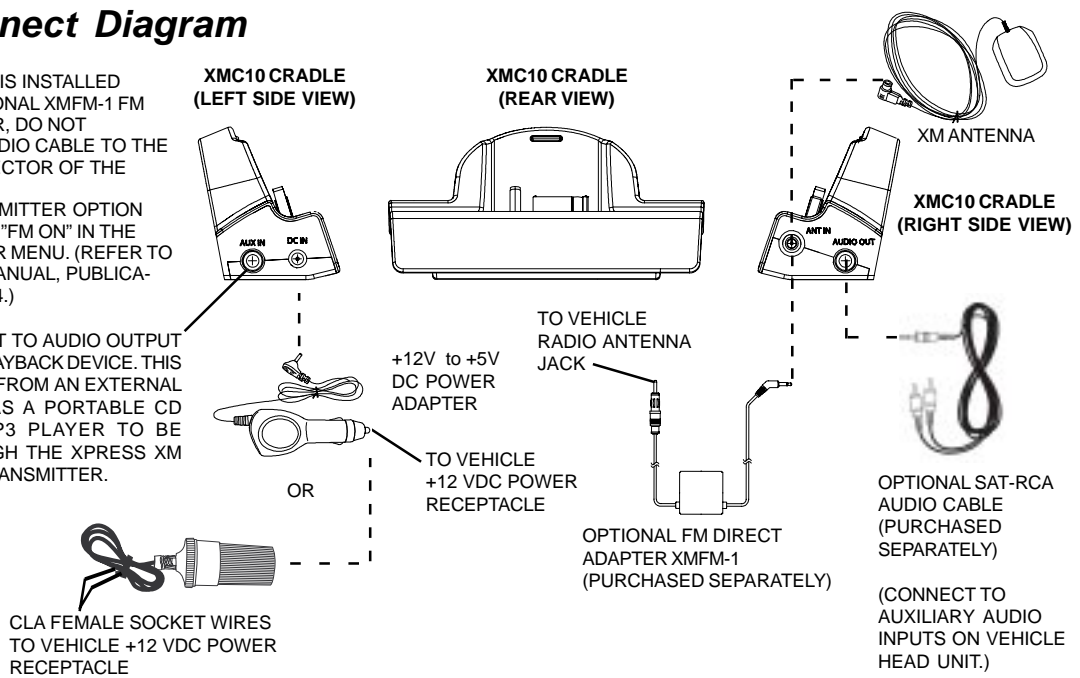

**CAUTION:** Do not install the swivel bracket on a leather or fabric surface, or in a position that could impair your vision, block air bag(s) or obstruct vehicle dashboard controls and/or radio CD/cassette operational displays.

**NOTE:** The adhesive backing on the bracket will not permit easy repositioning once it has been mated to the surface; use extreme care and planning when selecting the mounting location. If the bracket is to be screwed to the surface, make sure the area in back of the mounting surface is clear of wires or other items to prevent unintentional damage.

- c. Using the alcohol swab supplied with your kit, clean the mounting surface and thoroughly wipe the area dry with a clean lint-free cloth.
- d. If the outside air temperature is cold, it may be beneficial to warm the adhesive backing on

the bracket using a portable hair dryer, or by holding the backing surface in front of a vehicle heater vent.

- e. Remove the plastic liner from the adhesive backing on the bracket, and fix the base in position on the surface; make sure the mounting pad is accurately positioned on the first try, since repositioning may be difficult, if not impossible.
- f. If the bracket is to be screwed in place, do not remove the plastic liner from the adhesive backing. Use appropriate sheet metal or machine screws for this purpose.
- g. To mount the XMC10 cradle atop the swivel bracket, line up the slot at the rear of the cradle with the bracket retainer tab, and slide the cradle down so that the slot and tab mesh together in a locked position.

**NOTE:** Allow a 72-hour period for the adhesive backing to cure completely.



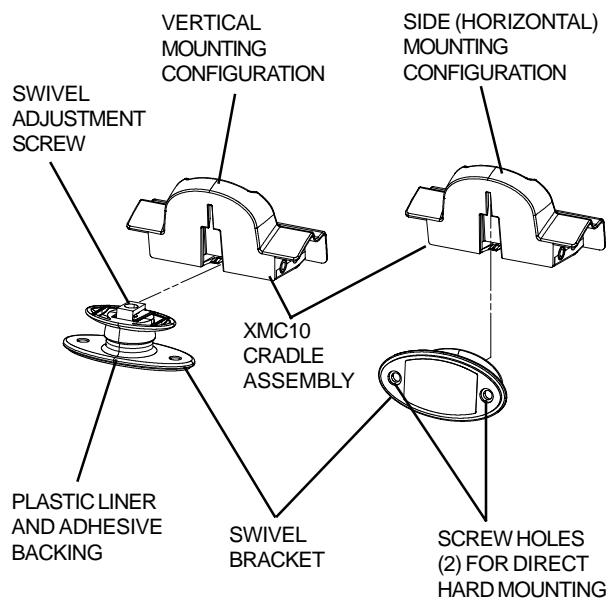

### 3. Using Other Manufacturer's Mounts

The XMC10 Cradle can also be installed using other manufacturer's mounts; the mounting plate provisions on the rear and bottom of the cradle provide you with two mounting options within the vehicle using various vehicle-specific aftermarket brackets.

### 4. Installing the Xpress XM<sup>®</sup> Receiver into the Cradle

Install the Receiver as follows:

- a. After making sure the connectors and guide pin hole are properly lined up, gently lower the Xpress XM<sup>®</sup> Receiver into the cradle and press down on the Xpress XM<sup>®</sup> Receiver to mate the connectors together. The raised detent on the cradle will enter the notch on the rear of the Receiver, indicating the Xpress XM<sup>®</sup> is properly seated.
- b. The Xpress XM<sup>®</sup> Receiver should now be secured in the cradle

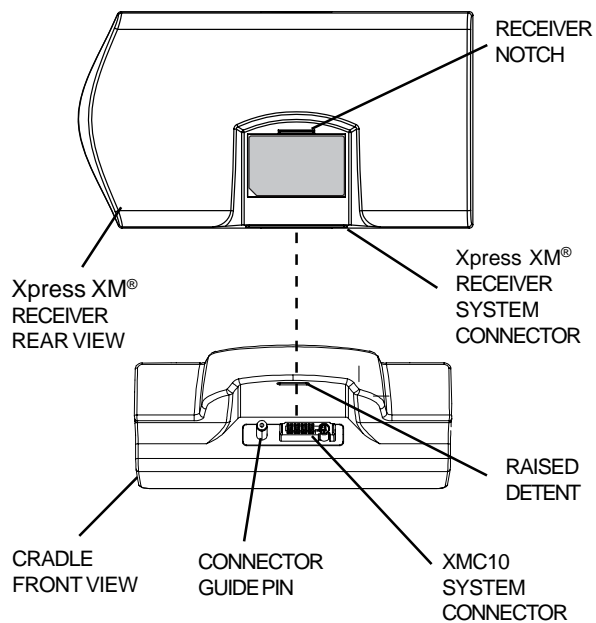

## 5. Connection Options

The Xpress Receiver and Cradle provide an audio output signal in three ways:

- a. **FM Wireless Transmitter** - When using the XMC10 cradle with the wireless FM transmitter option, the XM audio signal can be received through your vehicle radio on selectable FM frequencies using the menu options included in your Xpress Receiver. (Refer to the Receiver owner's manual.) The XM audio signal can then be played through your vehicle radio when the car radio is tuned to one of the available frequencies.

- b. **FM Direct Wiring** - If the FM wireless transmitter does not provide satisfactory performance in your vehicle, use the optional FM Direct Adapter, Part # XMFM-1, which provides a hard-wired FM output.
- c. **Low-Level Audio Output** - For vehicles equipped with radio head units with auxiliary audio inputs, the audio signal can be routed through an optional audio cable (Part No. SAT-RCA) and applied to the auxiliary inputs of a radio or entertainment system. In this case, it is best to turn the Xpress Receiver FM modulator option off to avoid interference.

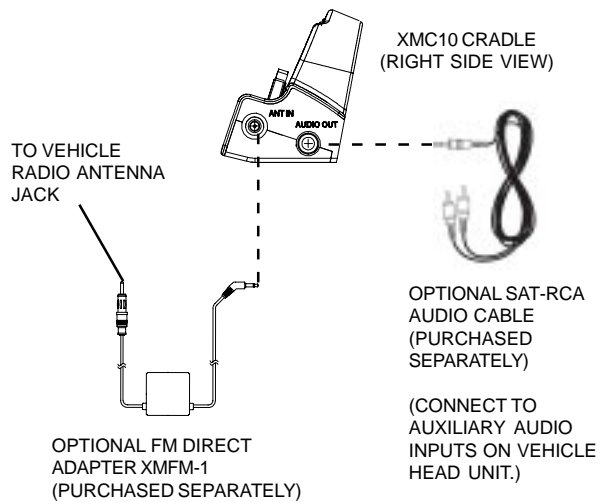

### 7. *Mounting the Vehicle Antenna*

The antenna should be placed on a relatively flat surface on the vehicle exterior, preferably on the roof (high point) or on the trunk (convertible). To mount the antenna:

- a. Plug the antenna into the ANT connector on the back of the cradle.
- b. Place the antenna at the preferred location on the roof or trunk surface. If the vehicle is equipped with a roof or trunk rack, the antenna may have to be mounted off-center on the surface. The magnet will secure the antenna in the desired position.
- c. Apply power to the Xpress XM system as outlined in the associated User Guide and obtain an audio output. If no audio is heard, first check the signal strength indicator located on the bottom left corner of the display to ensure the antenna is receiving an optimum signal. If necessary, move the antenna to different

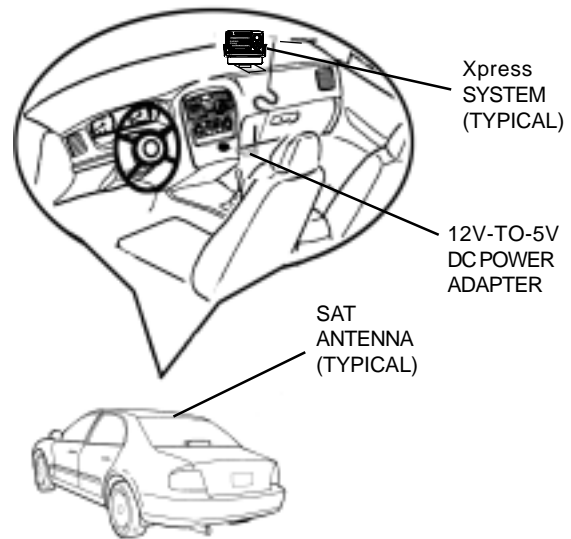

positions on the surface until an audio output is heard. The desired antenna position should be marked with masking tape or by another non-scratch method.

- d. After determining the optimum position, turn off Xpress XM power, disconnect the power adapter from the vehicle cigarette lighter receptacle and disconnect the antenna cable.
- e. Plan the routing of the antenna cable to the cradle. Make sure you avoid any obstructions that could crimp, kink or twist the cable; use protective grommets wherever rough openings are encountered.
- f. Route the cable from the antenna position to the interior of the vehicle, working the cable under the rear window molding; make adjustments and take up slack whenever necessary.

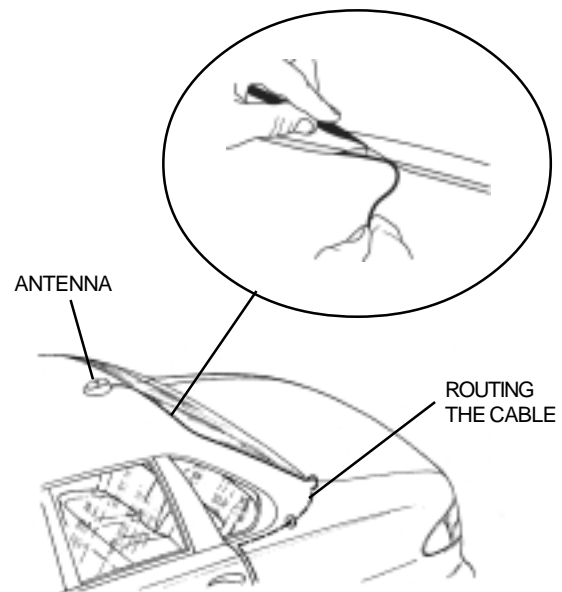

- g. At the lowest point of the rear window, route the cable into the trunk, taking advantage of existing cable conduits. Then snake the cable around the passenger compartment to the back of the XMC10 cradle.
- h. In SUV's, minivans, etc., route the cable into the vehicle under the rubber molding of the hatch door or tailgate, and then under the interior trim.  
**NOTE:** Avoid exposing the cable in the driver and passenger areas where it could become entangled in feet or other objects.
- i. Plug the antenna cable into the ANT connector on the back of the cradle; then plug the cigarette lighter adapter into the lighter receptacle.
- j. You are now ready to enjoy XM programming within your vehicle.



**AUDIOVOX**

## 12 MONTH LIMITED WARRANTY

AUDIOVOX ELECTRONICS CORPORATION (the Company) warrants to the original retail purchaser of this product that should this product or any part thereof, under normal use and conditions, be proven defective in material or workmanship within 12 months from the date of original purchase, such defect(s) will be repaired or replaced with new or reconditioned product (at the Company's option) without charge for parts and repair labor.

To obtain repair or replacement within the terms of this Warranty, the product is to be delivered with proof of warranty coverage (e.g. dated bill of sale), specification of defect(s), transportation prepaid, to an approved warranty station or the Company at the address shown below.

This Warranty does not extend to the elimination of externally generated static or noise, to costs incurred for installation, removal or reinstallation of the product, damage to speakers, accessories, or vehicle and home electrical systems, malfunction of satellite transmissions, repeater signal or receiver unit.

This Warranty does not apply to any product or part thereof which, in the opinion of the Company, has suffered or been damaged through alteration, improper installation, mishandling, misuse, neglect, accident, or by removal or defacement of the factory serial number/bar code label(s). THE EXTENT OF THE COMPANY'S LIABILITY UNDER THIS WARRANTY IS LIMITED TO THE REPAIR OR REPLACEMENT PROVIDED ABOVE AND, IN NO EVENT, SHALL THE COMPANY'S LIABILITY EXCEED THE PURCHASE PRICE PAID BY PURCHASER FOR THE PRODUCT.

This Warranty is in lieu of all other express warranties or liabilities. ANY IMPLIED WARRANTIES, INCLUDING ANY IMPLIED WARRANTY OF MERCHANTABILITY, SHALL BE LIMITED TO THE DURATION OF THIS WRITTEN WARRANTY. ANY ACTION FOR BREACH OF ANY WARRANTY HEREUNDER INCLUDING ANY IMPLIED WARRANTY OF MERCHANTABILITY MUST BE BROUGHT WITHIN A PERIOD OF 48 MONTHS FROM DATE OF ORIGINAL PURCHASE. IN NO CASE SHALL THE COMPANY BE LIABLE FOR ANY CONSEQUENTIAL OR INCIDENTAL DAMAGES FOR BREACH OF THIS OR ANY OTHER WARRANTY, EXPRESS OR IMPLIED, WHATSOEVER. No person or representative is authorized to assume for the Company any liability other than expressed herein in connection with the sale of this product.

Some states do not allow limitations on how long an implied warranty lasts or the exclusion or limitation of incidental or consequential damage so the above limitations or exclusions may not apply to you. This Warranty gives you specific legal rights and you may also have other rights which vary from state to state.

**U.S.A. :** AUDIOVOX ELECTRONICS CORPORATION, 150 MARCUS BLVD., HAUPPAUGE, NEW YORK 11788 (1-800-645-4994)

**CANADA :** CALL 1-800-645-4994 FOR LOCATION OF WARRANTY STATION SERVING YOUR AREA

128-7351

---

---

© 2005 Audiovox Electronics Corporation, 150 Marcus Blvd., Hauppauge, New York 11788

128-7472

128-7472

16 of 16